



VF2 TDR
LEVEL MEASUREMENT

WHY TDR FOR LEVEL MEASUREMENT?

INSENSITIVE TO CHANGES IN

- ◆ Dielectric
- ◆ Pressure
- ◆ Vacuum
- ◆ Humidity
- ◆ Dust
- ◆ Viscosity
- ◆ Foam
- ◆ Temperature

THE ADVANTAGES ARE

- ◆ Measuring ranges up to 40m
- ◆ Versatile technology for Liquids, Slurries, Pastes and Solids
- ◆ Display of Level, Distance or Volume
- ◆ 2 wire loop powered 24vDC
- ◆ Hazardous area options ATEX, EExd and Eexia
- ◆ HART, Profibus (PA) and Foundation Fieldbus
- ◆ Suitable for narrow tanks with small beam diameter
- ◆ DPR (Dynamic Parasite Rejection) eliminates false signals
- ◆ Unaffected by dust during fill or empty conditions
- ◆ Immune to fill noise on solid products such as stone
- ◆ Rotatable 360° housing for display orientation
- ◆ Horizontal or vertical housing position for every installation
- ◆ Simple to install and retrofit with range of process connections
- ◆ Suitable for corrosive and acidic atmospheres
- ◆ High temperature and pressure options are available
- ◆ Remote or local programming and configuration
- ◆ Suitable for detecting levels through surface foam
- ◆ Sealed Flange system maintains system integrity
- ◆ SIL2-compliant according to IEC 61508 for safety-related systems
- ◆ Snap coupling system permits removal under pressure
- ◆ Bayonet housing cover permits easy opening and closing

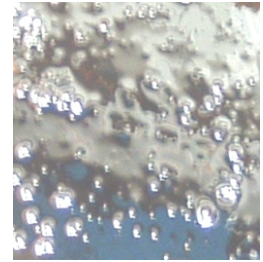

Acids

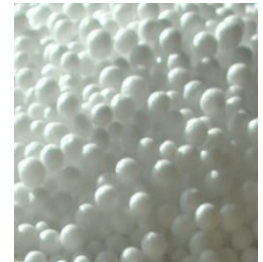

Plastics



Grain



Powders



Flakes

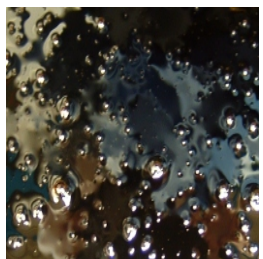

Oils

TDR FOR ALL INDUSTRIES

- ◆ Petrochemical
- ◆ Food
- ◆ Chemical
- ◆ Paint
- ◆ Water & Waste
- ◆ Cement
- ◆ Asphalt
- ◆ Minerals
- ◆ Power Generation
- ◆ Steel
- ◆ Quarrying
- ◆ Powder

TDR FOR A VARIETY OF APPLICATIONS

- ◆ Level Measurement
- ◆ Volume Measurement
- ◆ Interface Measurement
- ◆ Distance Measurement

COST EFFECTIVE REPLACEMENT FOR

- ◆ Capacitance transmitters
- ◆ Hydrostatic transmitters
- ◆ Differential pressure transmitters
- ◆ Displacers

TDR TECHNOLOGY

The Reflex VF Series range of TDR products is ideal for the measurement of liquids, powders and granules to a range of 40m. Unaffected by pressure, temperature, viscosity, vacuum, foam, dust, changes in dielectric constant or coating of the probe, the VF Series can measure virtually any product in either Direct, Automatic or TBF mode utilising any one of its seven probe types.

HOW DOES IT WORK?

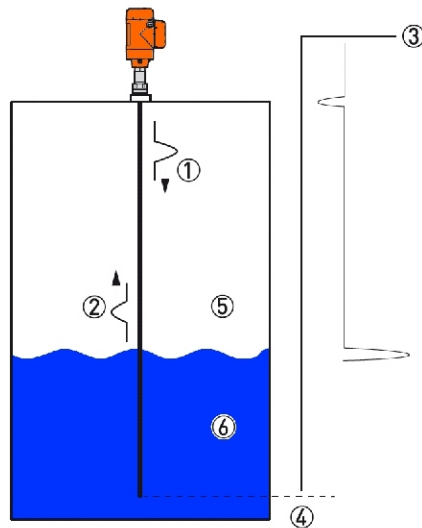

1. Transmitted Pulse
2. Reflected Pulse
3. Pulse amplitude
4. Time of flight
5. Air dielectric 1
6. Water dielectric >80

The VF2 TDR transmits low-intensity electromagnetic pulses of approximately one nano second width along a rigid or flexible conductor.

These pulses move at the speed of light and when the pulses reach the surface of the product to be measured, the pulses are reflected back to the signal converter.

The device then measures the time from when the pulse was transmitted to when it is received. This is then divided by two as this time is equivalent to the distance from the reference point of the device to the surface of the product. The time value is then converted into an output current of 4 to 20mA.

DYNAMIC PARASITE REJECTION (DPR) SOFTWARE

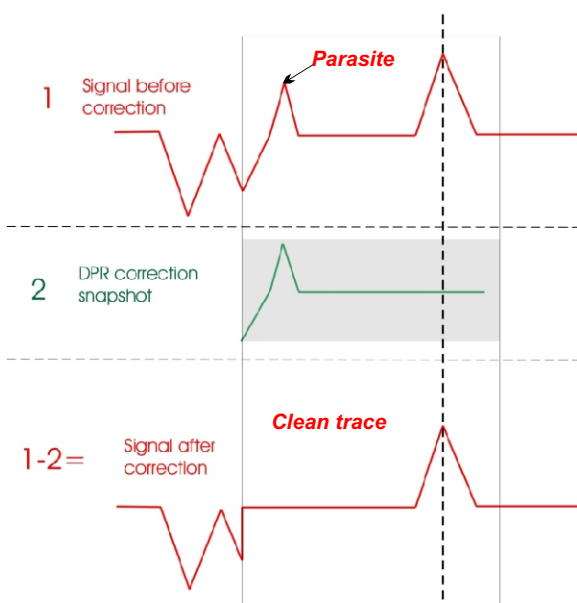

DPR is a new advancement of the software technology in the new TDR and is completed by utilising a dynamic monitoring software tool.

This feature is automatically enabled for every application and basically takes continuous sample snapshots to reference the return signal against. If you refer to the raw processed signal opposite as shown in diagram 1 a rogue parasite at the front end can be seen periodically.

The software will then reference the parasite against stored reference data so it then has the ability to ignore the false signals from internal tank obstructions such as down pipes, nozzle reflections, stirrers etc.

DPR provides increased signal stability by:-

- ◆ Removing parasite false pulse signals
- ◆ Improves accuracy by improving linearity
- ◆ Dynamic updates during measurement process

MODULAR TECHNOLOGY

The Reflex VF2 range of TDR products is ideal for the measurement of liquids, powders and granules for a variety of applications. These applications may require different instrument configurations such as remote displays, side mounted indicator displays, top mounted or simply just a plain 'blind' instrument. The VF2 range provides flexibility within its range by simply reconfiguring the instrument with a basic building block configuration. For ultimate flexibility this range is then combined with one of 8 different probe types providing hundreds of different combinations to suit all applications.

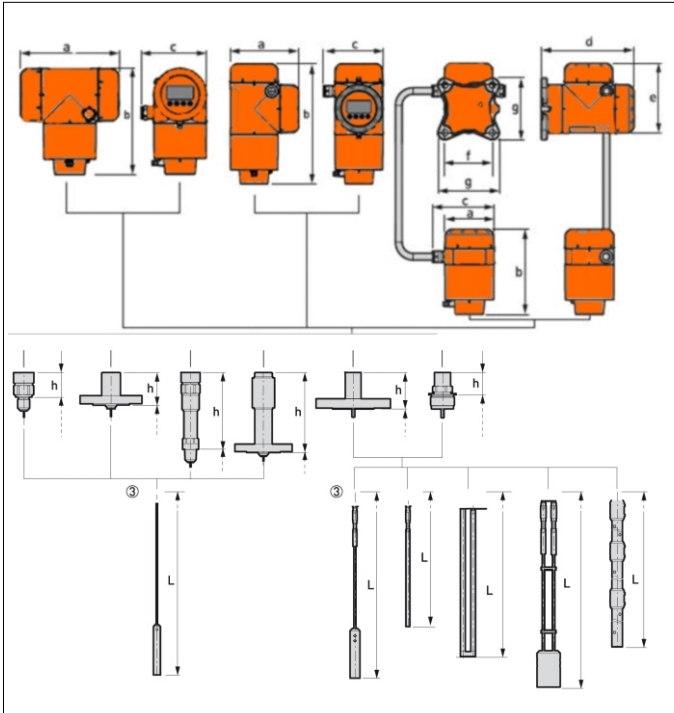

FLEXIBLE REMOTE DISPLAY OPTIONS

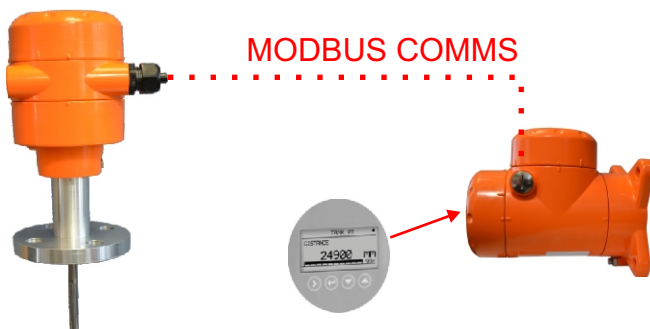

With this option operators can now read the tank level measurements from ground level and configure the device without having to climb to the top of the tank. This saves time, reduces maintenance and reduces the risk of slips trips and falls from height. The remote converter can be installed up to 100 m / 328 ft away from the process connection on the tank.

The remote housing can be attached to a wall, pipe or rigid surface with the supplied wall support mounting bracket.

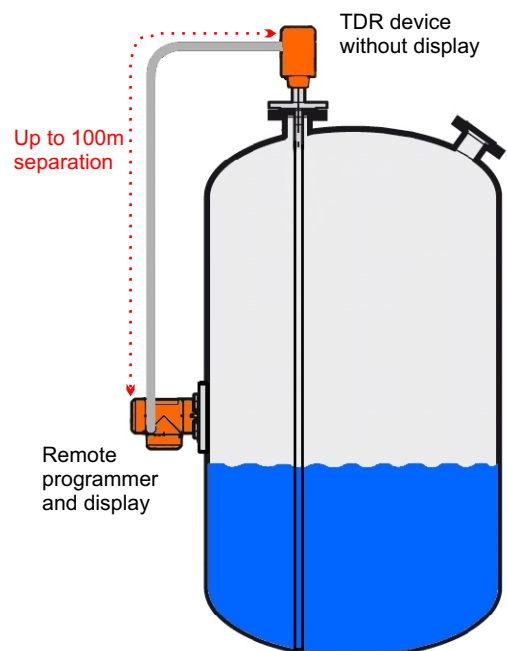

DISPLAY AND PROGRAMMING

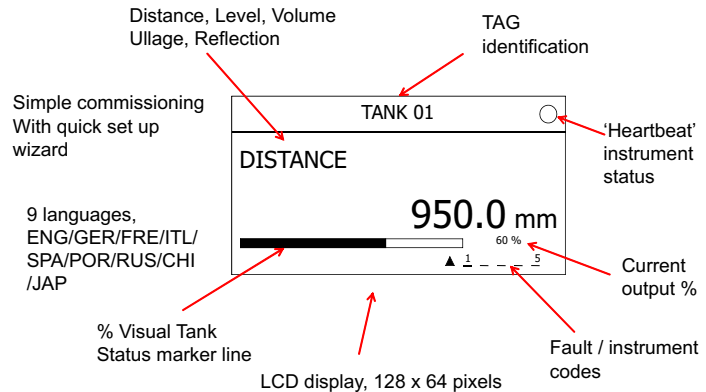

The display for programming and level indication can be ordered with the device or purchased separately as an accessory at a later date. This provides a cost saving if you have multiple units but do not require a display on the tank top but would like the flexibility of being able to program the units without a laptop as one display can program multiple units. The display screen is 128 x 64 pixels and the programming of the instrument is via a simple four button keypad which is menu driven.

The unit is designed to be programmed for simple applications without the need for a detailed manual enabling a fast and efficient commissioning.

The display is available in nine different languages and includes tank ID data, the level or distance, fault codes and percentage full bars.



PRODUCT FEATURES

QUICK RELEASE

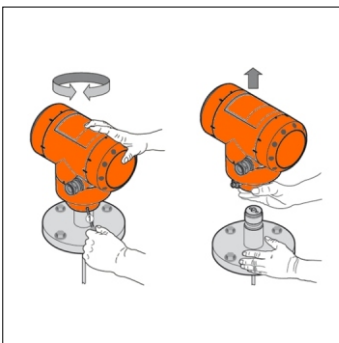

The quick coupling modular system enables removal of the housing without breaking the seal with the tank. This is ideal for hazardous or pressurised vessels as the electronics can be removed simply leaving the process connection in place.

This also enables the housing to be rotated 360 degrees for installation ease.

ANTI-BLOWOUT



Installation of slip on flanges reduces installation costs.

The TDR core is threaded but the core passes through the flange above the threaded part. This method prevents the core from passing through the flange in the event of a thread failure and an overpressure as the shoulder provides additional safety support.

CORROSIVE



For many industries such as chemical, offshore and oil and gas a high degree of protection is required for the instrument.

Stainless steel is a recognised and accepted material for these types of applications and combined with the wide variety of flanges and process connections offers a very flexible solution.

PROBE SELECTION GUIDE

1. Install the device in a stilling well or a bypass chamber
2. Make a selection from one of these 2 options: a probe made of Hastelloy® C-22 or a probe with a PVC, PVDF or PP protective sheath
3. Use a probe made of Hastelloy® C-22
4. Use this probe with an anchor fitting. For more data, refer to the handbook.
5. Max. length is 20 m / 65.5 ft, more on request

	Double rod	Single Rod	Single Rod Segmented	Coaxial	Coaxial Segmented	Double cable	Single Cable 4mm / 0.15"	Single Cable 2mm / .08"
Maximum probe length, L								
4m / 13 ft								
6m / 20 ft								
40 m / 130 ft								
Liquids								
Liquid application								
LPG, LNG		1	1				1	1
Highly viscous liquids								
Highly crystallising liquids								
Highly corrosive liquids		2	3					
Foam								
Agitated liquids	4	4	4	4	4	4	4	4
Spray in tank		1	1				1	1
Storage tanks								
Installation in bypass chamber								
Small diameter nozzles and long nozzles		4	4				4	4
Stilling wells								
Solids								
Powders							5	
Granules, <5 mm / 0.2"							5	



Coaxial Segmented



Coaxial Solid

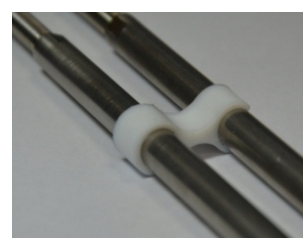

Twin Rod



Single Cable



Twin Cable



Single Rod Segmented

TECHNICAL DATA

TECHNICAL INFORMATION

The following data is provided for general applications. If you require data that is more relevant to your specific application, please contact Hycontrol or your local representative.

Additional information (certificates, special tools, software etc.) and complete product documentation can be downloaded free of charge from the Hycontrol website (www.hycontrol.com).

Measuring system	
Application	Level and volume measurement of liquids, pastes, powders and granulates
Measuring principle	TDR (time domain reflectometry)
Construction	Measuring probe attached directly to a signal converter
Operating conditions	
Ambient temperature	-40...+80°C / -40...+176°F Integrated LCD display: -20...+60°C / -5...+140°F; if the ambient temperature is not in these limits, the display switches off
Storage temperature	-50...+85°C / -60...+185°F (min. -40°C / -40°F for devices with the integrated LCD display option)
Protection category	IP 66/67 equivalent to NEMA type 4X (housing) and type 6P (probe)
Materials	
Housing	Polyester-coated aluminium or stainless steel (1.4404 / 316L)
Cable entry	Plastic (non-Ex devices: black, intrinsically-safe devices: blue); nickel-plated brass (explosion proof devices only), stainless steel (explosion proof devices only)
Electrical connections	
Power supply (terminals)	Terminals output - Non-Ex / Ex i: 12...30 VDC; min./max. value for an output of 22 mA at the terminal Terminals output - Ex d: 16...36 VDC; min./max. value for an output of 22 mA at the terminal
Current output load	Non-Ex / Ex i: $R_L [\Omega] \leq ((U_{ext} - 12 \text{ V}) / 22 \text{ mA})$. For more data, refer to Minimum power supply voltage on page 15. Ex d: $R_L [\Omega] \leq ((U_{ext} - 16 \text{ V}) / 22 \text{ mA})$. For more data, refer to Minimum power supply voltage on page 15.
Cable entry	M20 × 1.5; ½ NPT
Cable gland	Standard: none Options: M20×1.5 (cable diameter: 6...12 mm / 0.23...0.47"); others are available on request
Communication cable - remote version	None for non-Ex devices (4-wire shielded cable of max. length 100 m / 328 ft to be supplied by the customer). Supplied with all Ex-approved devices.
Cable entry capacity (terminal)	0.5...1.5 mm ²
Input and output	
Measured variable	Time between the emitted and received signal
Output signal	4...20 mA HART® or 3.8...20.5 mA acc. to NAMUR NE 43 1
Resolution	±1 µA
Error signal options	High: 22 mA; Low: 3.6 mA acc. to NAMUR NE 43; Hold (frozen value - not available if the output agrees with NAMUR NE 43) 2

Display and user interface	
User interface options	LCD display (128 × 64 pixels in 8-step greyscale with 4-button keypad)
Languages	9 languages are available: English, German, French, Italian, Spanish, Portuguese, Japanese, Chinese (Mandarin) and Russian
Approvals and certification	
CE	This device fulfils the statutory requirements of the EC directives. The manufacturer certifies successful testing of the product by applying the CE mark.
Vibration resistance	EN 60721-3-4 (1...9 Hz: 3 mm / 10...200 Hz:1g; 10g shock ½sinus: 11 ms)
Explosion protection	
ATEX DEKRA 11ATEX0166 X	II 1/2 G, 2 G Ex ia IIC T6...T3 (or T2) Ga/Gb or Ex ia IIC T6...T3 (or T2) Gb;
	II 1/2 D, 2 D Ex ia IIIC T90°C Da/Db or Ex ia IIIC T90°C Db IP6X;
	II 1/2 G, 2 G Ex d ia IIC T6...T3 (or T2) Ga/Gb or Ex d ia IIC T6...T3 (or T2) Gb;
	II 1/2 D, 2 D Ex ia tb IIIC T90°C Da/Db or Ex ia tb IIC T90°C Db IP6X
IECEX IECEX DEK 11.0060 X	Ex ia IIC T6...T3 (or T2) Ga/Gb or Ex ia IIC T6...T3 (or T2) Gb;
	Ex ia IIIC T90°C Da/Db or Ex ia IIIC T90°C Db IP6X;
	Ex d ia IIC T6...T3 (or T2) or Ex d ia IIC T6...T3 (or T2) Gb;
	Ex ia tb IIIC T90°C Da/Db or Ex ia tb IIIC T90°C IP6X
cFMus - Dual Seal-approved (pending)	NEC 500
	XP-IS / Cl. I / Div. 1 / Gr. ABCD / T6;
	DIP / Cl. II/III / Div. 1 / Gr. EFG / T6;
	IS / Cl. I/II/III / Div. 1 / Gr. ABCDEFG / T6;
	NI / Cl. I / Div. 2 / Gr. ABCD / T6
	NEC 505
	Cl. I / Zone 0 / AEx d [ia] / IIC / T6;
	Cl. I / Zone 0 / AEx ia / IIC / T6;
	Cl. I / Zone 2 / AEx nA [ia] / IIC / T6;
	Hazardous (Classified) Locations, indoor/outdoor Type 4X and 6P, IP66, Dual Seal
	CEC Section 18 (Zone ratings)
	Cl. I, Zone 1, Ex d, IIC (Probe: Zone 0), T6;
	Cl. I, Zone 0, Ex ia, IIC, T6;
	Cl. I, Zone 2, Ex nA, IIC, T6 DIP A21 IP66 TB 95°C
	CEC Section 18 and Annex J (Division ratings)
Cl. I, Div. 1/2, Gr. ABCD; Cl. II, Gr. EFG; Cl. III, T6;	
NEPSI (pending)	Ex ia IIC T2/T3~T6 DIP A21 TA IP66;
	Ex dia IIC T2/T3~T6 DIP A21 TA IP66

Other standards and approvals	
SIL	Compact version only: SIL 2 - certified according to all the requirements in EN 61508 (Full Assessment) and for high/low demand mode operation. HFT=0, SFF=94.3% (for non-Ex / Ex i devices) or 92.1% (for Ex d devices), type B device
EMC	EMC Directives 2004/108/EC in conjunction with EN 61326-1 (2006). The device agrees with this standard if the time constant ? 3 seconds and: - the device has a coaxial probe or - the device has a single / double probe that is installed in a metallic tank. For more data. SIL 2-approved devices agree with EN 61326-3-1 (2006) and EN 61326-3-2 (2006)
NAMUR	NAMUR NE 21 Electromagnetic Compatibility (EMC) of Industrial Process and Laboratory Control Equipment
	NAMUR NE 43 Standardization of the Signal Level for the Failure Information of Digital Transmitters
	NAMUR NE 107 Self-Monitoring and Diagnosis of Field Devices
CRN (pending)	This certification is for all Canadian provinces and territories. For more data, refer to the website.
Construction code	On request: NACE MR0175 / ISO 15156; NACE MR0103

TECHNICAL DATA

Probe options			
	Single cable Ø2 mm / 0.08"	Single cable Ø4 mm / 0.16"	Single rod Ø8 mm / 0.31"
Measuring system			
Application	Liquids	Liquids and solids	
Measuring range	1...40 m / 3.3...131 ft	Liquids: 1...40 m / 3.3...131 ft Solids: 1...20 m / 3.3...65.6 ft	1...6 m / 3.3...19.7 ft
Dead zone	This depends on the type of probe. For more data, refer to Measurement limits		
Measuring accuracy			
Accuracy (in direct mode)	Standard: ±10 mm / ±0.4", when distance < 10 m / 33 ft; ±0.1% of measured distance, when distance > 10 m / 33 ft Optional: ±3 mm / ±0.1", when distance < 10 m / 33 ft; ±0.03% of measured distance, when distance > 10 m / 33 ft		
Accuracy (in TBF mode)	±20 mm / ±0.8"		
Resolution	1 mm / 0.04"		
Repeatability	±1 mm / ±0.04"		
Maximum rate of change at 4 mA	10 m/min / 32.8 ft/min		
Operating conditions			
Max. temperature at the process connection (also depends on the temperature limits of the gasket material. Refer to "Materials" in this table.)	-50...+300°C/ -58...+572°F	-50...+150°C / -58...+302°F	
Pressure	-1...40 barg / -14.5...580 psig		
Viscosity (liquids only)	10000 mPa.s / 10000 cP		
Dielectric constant	≥ 1.8 in direct mode; ≥ 1.1 in TBF mode		
Materials			
Probe	Stainless steel (1.4404 / 316L)	Stainless steel (1.4401 / 316); Hastelloy® C-22 (2.4602)	
Gasket (process seal)	FKM/FPM (-40...+300°C/ -40...+572°F); Kalrez® 6375 (-20...+300°C / -4...+572°F); EPDM (-50...+250°C / -58...+482°F) 1	FKM/FPM (-40...+150°C / -40...+302°F); Kalrez® 6375 (-20...+150°C / -4...+302°F); EPDM (-50...+150°C / -58...+302°F) 1	
Process connection	Stainless steel (1.4404 / 316L); Hastelloy® C-22 (2.4602)		
Process connections			
Thread	For more data on options, refer to price list		
Flange	For more data on options, refer to price list		

TECHNICAL DATA

RANGE AND ACCURACY

	Double cable 2 × Ø4 mm / 0.16"	Double rod 2 × Ø8 mm / 0.31"	Coaxial Ø22 mm / 0.9"
Measuring system			
Application	Liquids		
Measuring range	1...40 m / 3.3...131 ft	1...4 m / 3.3...13.1 ft	1...6 m / 3.3...19.7 ft
Dead zone	This depends on the type of probe. For more data, refer to Measurement limits.		
Measuring accuracy			
Accuracy (in direct mode)	Standard: ±10 mm / ±0.4", when distance ≤ 10 m / 33 ft; ±0.1% of measured distance, when distance > 10 m / 33 ft Optional: ±3 mm / ±0.1", when distance ≤ 10 m / 33 ft; ±0.03% of measured distance, when distance > 10 m / 33 ft		
Accuracy (in TBF mode)	±20 mm / ±0.8"		
Resolution	1 mm / 0.04"		
Repeatability	±1 mm / ±0.04"		
Maximum rate of change at 4 mA	10 m/min / 32.8 ft/min		
Operating conditions			
Max. temperature at the process connection (also depends on the temperature limits of the gasket material. Refer to "Materials" in this table.)	-50...+150°C / -58...+302°F		
Pressure	-1...40 barg / -14.5...580 psig		
Viscosity (liquids only)	10000 mPa.s / 10000 cP	1500 mPa.s / 1500 cP	500 mPa.s / 500 cP
Dielectric constant	≥1.6 in direct mode		≥1.4 in direct mode
	≥1.1 in TBF mode		
Materials			
Probe	Stainless steel (1.4404 / 316L)	Stainless steel (1.4401 / 316); Hastelloy® C-22 (2.4602)	
Gasket (process seal)	FKM/FPM (-40...+150°C / -40...+302°F); Kalrez® 6375 (-20...+150°C / -4...+302°F); EPDM (-50...+150°C / -58...+302°F) 1		
Process connection	Stainless steel (1.4404 / 316L); Hastelloy® C-22 (2.4602)		
Process connections			
Thread	For more data on options, refer to Order code		

TECHNICAL INFORMATION

The following data is provided for general applications. If you require data that is more relevant to your specific application, please contact us or your local representative.

Additional information (certificates, special tools, software,...) and complete product documentation can be downloaded free of charge from the Hycontrol website.

HOUSING DIMENSIONS

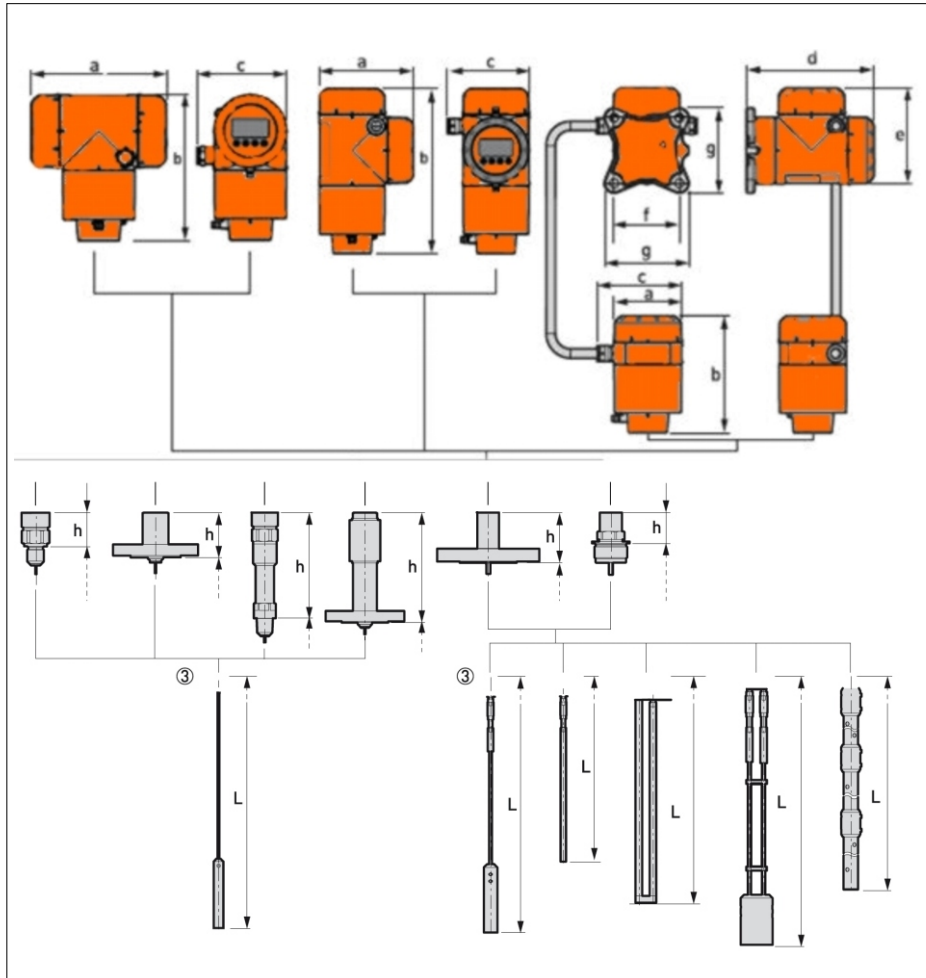

1. Housing options. From left to right: compact converter with horizontal housing, compact converter with vertical housing, and remote converter (top) and probe housing (bottom)
 2. Process connection options. From left to right: threaded connection for $\text{Ø}2$ mm / 0.08" single cable probe, flange connection for $\text{Ø}2$ mm / 0.08" single cable probe, high-temperature (HT) threaded connection for $\text{Ø}2$ mm / 0.08" single cable probe, HT flange connection for $\text{Ø}2$ mm / 0.08" single cable probe, threaded connection for other probes, flange connection for other probes
 3. Probe options. From left to right: $\text{Ø}2$ mm / 0.08" single cable probe, $\text{Ø}4$ mm / 0.16" single cable probe, single rod (single-piece or segmented) probe, double rod probe, $\text{Ø}4$ mm / 0.16" double cable probe and coaxial (single-piece or segmented) probe
- All housing covers have bayonet connectors unless it is an explosion-proof (XP / Ex d-approved) device. The terminal compartment cover for explosion-proof devices have a thread with a flame path.

DIMENSIONS

Housing options: Dimensions in mm						
Housing options: Dimensions in inches						
Process connection and probe options: Dimensions in mm						
Dimensions [mm]	Compact - horizontal		Compact - vertical		Remote	
	Non-Ex / Ex i / IS	Ex d / XP	Non-Ex / Ex i / IS	Ex d / XP	Non-Ex / Ex i / IS	Ex d / XP
a	191	258	147	210	104	104
b	123	123	209	209	142	142
c	127	127	127	127	129	129
d	-	-	-	-	184	184
e	-	-	-	-	163	226
f	-	-	-	-	100	100
g	-	-	-	-	155	155
Dimensions [inches]	Compact - horizontal		Compact - vertical		Remote	
	Non-Ex / Ex i / IS	Ex d / XP	Non-Ex / Ex i / IS	Ex d / XP	Non-Ex / Ex i / IS	Ex d / XP
a	7.5	10.2	5.79	8.27	4.09	4.09
b	4.84	4.84	8.23	8.23	5.59	5.59
c	5.00	5.00	5.00	5.00	5.08	5.08
d	-	-	-	-	7.24	7.24
e	-	-	-	-	6.42	8.90
f	-	-	-	-	3.94	3.94
g	-	-	-	-	6.10	6.10
Dimensions [mm]	Probes with threaded connections			Probes with flange connections		
	Ø2 mm single cable probe	HT Ø2 mm single cable probe	Other probes	Ø2 mm single cable probe	HT Ø2 mm single cable probe	Other probes
h	43	169	45	61	186	73
L	For more data, refer to "Single probes" and "Double and coaxial probes" in this section.					
Process connection and probe options: Dimensions in inches						
Dimensions [inches]	Probes with threaded connections			Probes with flange connections		
	Ø0.08" single cable probe	HT Ø0.08" single cable probe	Other probes	Ø0.08" single cable probe	HT Ø0.08" single cable probe	Other probes
h	1.69	6.65	1.77	2.40	7.32	2.87
L	For more data, refer to "Single probes" and "Double and coaxial probes" in this section.					

HYCONTROL LEVEL TECHNOLOGIES

Product Range For Solids :-

- (1) TDR Radar For Solids
- (2) Ultrasonic, 'Through Air'
- (2) 2 Wire Ultrasonic Transmitter
- (3) FMCW 2 Wire Radar
- (4) Continuous 'Servo' Level Indicator
- (5) FMCW 2 Wire Radar
- (6) Capacitance Level Switch
- (7) Vibrating Probe Level Switch
- (8) Rotating Paddle Level switch
- (9) Microwave Level Switch
- (10) Doppler Flow Switch

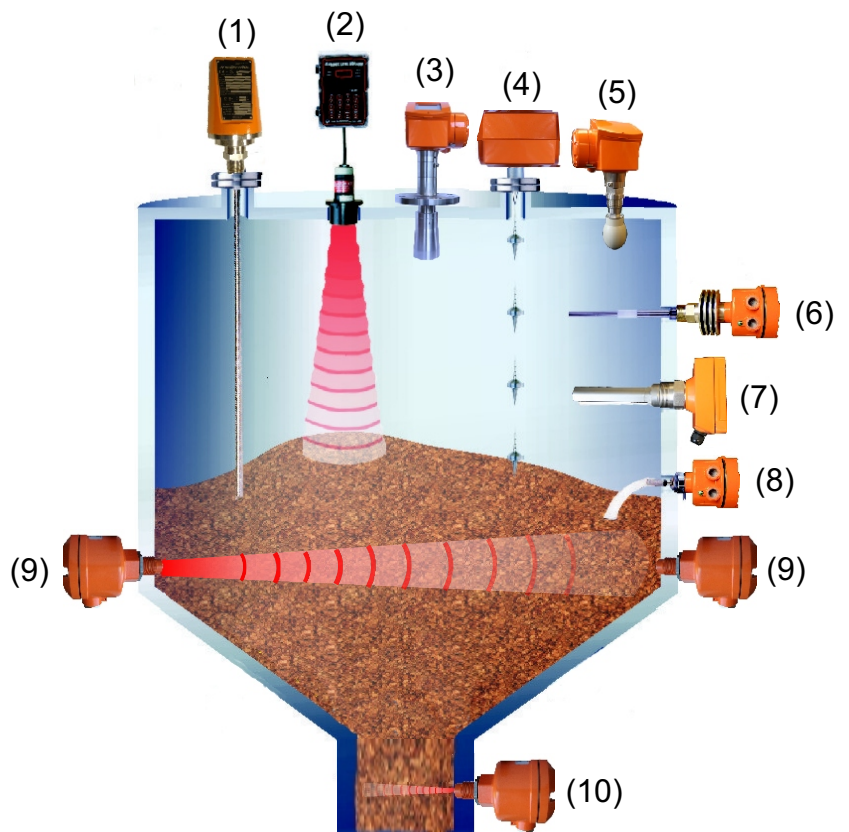

Product Range For Liquids :-

- (1) By-Pass Level Indicator With Radar
- (2) TDR Radar For Liquids
- (3) 2 Wire Ultrasonic Transmitter
- (4) FMCW 'Horn' Radar 2 Wire
- (5) Magnetic Float Switches
- (6) FMCW 2 Wire Radar
- (7) Capacitance Level Switch
- (8) RF Admittance Level Switch
- (9) Side Mounting 316 SS Float Switch
- (10) Tuning Fork Level Switch
- (11) Tuning Fork Level Switch
- (12) Ultrasonics 'Through Wall'
- (13) Mini Magnetic Float Level Switch

